

EPDM Rubber

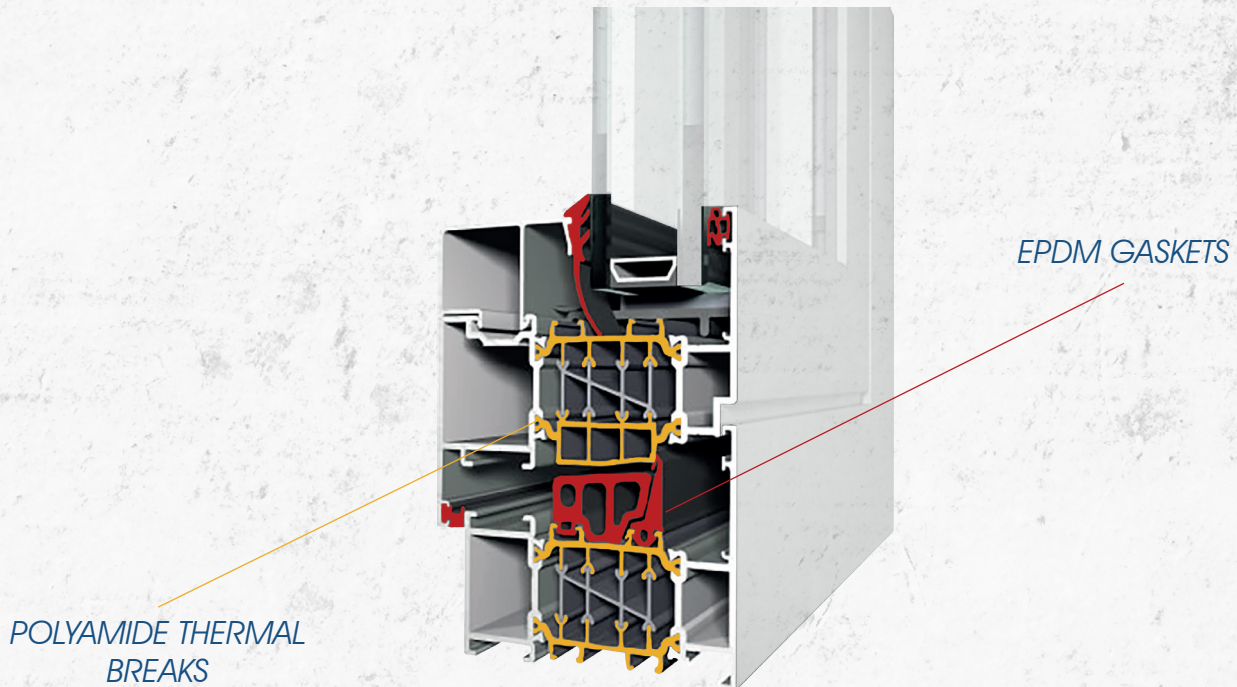

EPDM GASKETS

ЭПДМ УПЛОТНИТЕЛЬ



EPDM Rubber

EPDM Rubber

EPDM Rubber

EPDM Rubber

EPDM Rubber

EPDM Rubber

EPDM Rubber

EPDM Rubber

EPDM Rubber

EPDM Rubber

EPDM Rubber

EPDM Rubber

EPDM Rubber

EPDM Rubber

EPDM Rubber

EPDM Rubber

EPDM Rubber

EPDM Rubber

EPDM Rubber

EPDM Rubber

EPDM Rubber

EPDM Rubber

EPDM Rubber

EPDM Rubber

EPDM Rubber

EPDM Rubber

EPDM Rubber

EPDM Rubber

EPDM Rubber

EPDM Rubber

www.nabat.com.tr

EPDM Rubber

EPDM Rubber

EPDM Rubber

EPDM Rubber

EPDM Rubber

EPDM Rubber

EPDM Rubber

EPDM Rubber

EPDM Rubber

EPDM Rubber

EPDM Rubber

EPDM Rubber

EPDM Rubber

EPDM Rubber

EPDM Rubber

EPDM Rubber

EPDM Rubber

EPDM Rubber

EPDM Rubber

EPDM Rubber

EPDM Rubber

EPDM Rubber

EPDM Rubber

EPDM Rubber

EPDM Rubber

EPDM Rubber

EPDM Rubber

EPDM Rubber

EPDM Rubber

EPDM Rubber



NABAT GROUP (NABAT - Rubber Manufacturer and trade factory). Our organization is manufacturing **EPDM Gaskets** for PVC profiles, Aluminium profiles and Wood Profiles, EPDM injection parts for construction systems from aluminum and various injection materials. NABAT is engaged also in production on the basis of rubber for the automobile and construction industries. The main range for automotive industry rubber gaskets for glasses and the doors makes, many versions of sponge profiles, profiles with an injection, smashes also other injective parts, rubber segments and hoses. Control of quality of the raw materials used in production is carried out according to the most known standards in branch. For this purpose in the order of firm there is completely equipped laboratory. Forms of all products are developed on modern programs and made in department of production of forms. NABAT will help you in development and designing of new sealing profiles according to drawings or samples of the customer. EPDM Gaskets work in the wide range of working temperatures: from -55 to +135 °C, possess low residual deformation, have different degree of hardness, an excellent external surface.

- EPDM Gaskets for PVC systems
- EPDM Gaskets for Aluminium systems
- EPDM Gaskets for Wood systems
- EPDM Gaskets for PVC systems
- EPDM Gaskets for Mosquito systems
- EPDM Gaskets for External surfaces
- TPV, TPE, SBS & Grey Epdm Gaskets



NABAT GROUP (фирма «НАБАТ» - резинопроизводственная промышленность и торговля). Организация занимается производством **EPDM уплотнителей** для ПВХ профилей, Алюминевых профилей и Дерева, инъекционные угловые прокладки для строительных систем из алюминия и различные инъекционные материалы. НАБАТ занимается и производством продукции на базе каучука для автомобильной и строительной промышленности. Основной ассортимент для автомобилестроения составляют резиновые прокладки для стекол и дверей, многие разновидности губковых профилей, профили с инъекцией, громет и прочие инъективные части, резиновые сегменты и шланги. Контроль за качеством сырья, используемого в производстве осуществляется по самым известным стандартам в отрасли. Для этой цели в распоряжении фирмы имеется полностью оснащенная лаборатория. Формы всех продуктов разрабатываются на современных программах и изготавливаются в отделе по изготовлению форм. НАБАТ окажет Вам помощь в разработке новых уплотнительных профилей по чертежам или образцам заказчика с последующим изготовлением продукции на производстве, ЭПДМ Уплотнители работают в широком диапазоне рабочих температур: от -55 до +135°C, обладают низкой остаточной деформацией, имеют разную степень твердости, отличную внешнюю поверхность.

- ЭПДМ Уплотнители для ПВХ конструкций
- ЭПДМ Уплотнители для Алюминевых конструкций
- ЭПДМ Уплотнители для Деревянных конструкций
- ЭПДМ Уплотнители для Москитных систем
- ЭПДМ Уплотнители для Фасадных конструкций
- ТПВ, ТПЕ, СБС, Серый Эпдм

EPDM Rubber

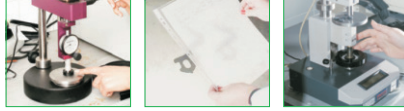

EPDM Rubber



EPDM Rubber



EPDM Rubber



EPDM Rubber

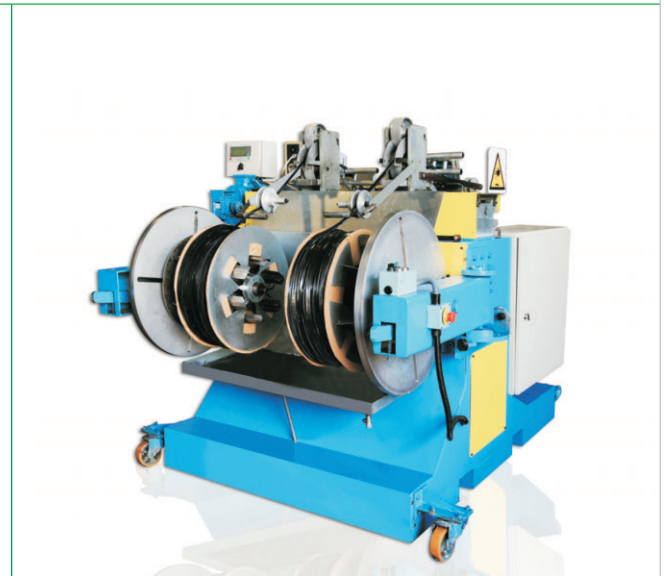

INDEX

PVC GROUP	Page
ADOPEN	1
ADVANCED TECH	1
AKANSUPEN	1
AROCO	2
ALUPLAST	2
ALPSANPEN	2
ARTEC	3
ASASPEN	3
EUROPLAST	4
EUROLINE	4
EXPROF	4
EUROPEN	4
FİLPEN	4
GEALAN	5
FIRATPEN	5
GÜNELPEN	5
INTERPLAST A	6
KALPEN	6
KBE	6
KOMPEN	7
KEBANPEN	7
KOMMERLING	7
LG	8
MAHJOUR	8
LAOUMANN	8
MUHTELIF PVC	8
PLAFEN	9
PLASPEN	9
PLASTMO	9
PLUSTEK	10
PROLINE	10
POLİPEN	10
REHAU	10
PROKAL	10
RESMAN	11
SALAMANDER	11
SCHEFFER	11
SECPEN	11
SARAY PEN	11
STARPEN	11
VEGA	12
VEKA	12
VISTA BEST	12
WELTPLAST	12
WINAPEX	13
WINDOLINE	13
WINTECH	13
WINTEC ROMANYA	13
WORLDPEN	13
Y. TURKUAZ	13

ALUMINIUM GROUP	Page
AÇI CEPHE SİSTEMLERİ	14
ADEN ALM.	14
ADVANCED TECH.	14
AGRISOVGAZ	14
AKOTHERM	16
AKEL METAL	16
AKPA	16
AKFA	16
ALPROF	17
ALUMİN TECHNO	19
ALUTRADE	19
ALUWINDOOR	20
ARABIAN ALM.	21
AMS	21
ARABIAN	21
ARHİTRAVİ	22
ARIA	22
ASAŞ ALM.	22
ARDEN	22
REAYNERS	25
RENOPLAN	25
SARAYDÖKÜM	26
TATPROF	29
STİMEX	29
TALİSMAN	29
TASHCO	29

ENDÜSTRİYEL GROUP	Page
ENDÜSTRİYEL GROUP	30
POLYAMIDE THERMAL BREAKS GROUP	Page
POLYAMIDE THERMAL BREAKS GROUP	33

PVC GROUP

section отрезок	cust ref nr номер клиентна	code nr код но.	packing погонные м.
	-	8128	250m
	-	5010	277m
	-	5019	250m
	-	5083	234m
	-	5375	238m
	-	5376	294m
	-	5377	230m
	-	5378	306m
	-	5389	258m
	-	5391	283m

section отрезок	cust.ref.nr. номер клиентна	code nr. код но.	packing погонные м.
	-	5392	365m
	-	5281	340m
	-	5282	270m
	-	5415	350m
	-	5378	150m
	8Z-02.424	5439	300m

ADVANCED TECH

	-	5452	410m
	-	5453	355m
	-	5097	330m

AKANSUPEN

	-	5093	288m
--	---	------	------

PVC GROUP

section отрезок	cust.ref.nr. номер клиентна	code nr. код но.	packing погонные м.
--------------------	--------------------------------	---------------------	------------------------

	-	5237	273m
--	---	------	------

	-	5261	394m
--	---	------	------

ALPSANPEN

	-	5045	200m
--	---	------	------

	-	5046	340m
--	---	------	------

	-	5033	394m
--	---	------	------

	-	5176	263m
--	---	------	------

	-	5026	230m
--	---	------	------

ALUPLAST

	459.922	5099	350m
--	---------	------	------

	-	5100	600m
--	---	------	------

	-	5101	350m
--	---	------	------

section отрезок	cust.ref.nr. номер клиентна	code nr. код но.	packing погонные м.
--------------------	--------------------------------	---------------------	------------------------

	-	5102	270m
--	---	------	------

	429340T	5227	450m
--	---------	------	------

	459925T	5228	350m
--	---------	------	------

	-	5329	300m
--	---	------	------

AROCCO

	WINTECH	5132	390m
--	---------	------	------

	WINHOUSE	5180	420m
--	----------	------	------

	ADOPEN	5375	270m
--	--------	------	------

	HOFMANN	5113	370m
--	---------	------	------

	BUTIA	5420	370m
--	-------	------	------

	BUTIA	5421	250m
--	-------	------	------



PVC GROUP

section отрезок	cust.ref.nr. номер клиентна	code nr. код но.	packing погонные м.
--------------------	--------------------------------	---------------------	------------------------

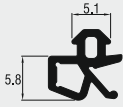
	HOME RESHTAN	5416	350m
---	-----------------	------	------

	HOME RESHTAN	5417	300m
---	-----------------	------	------

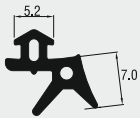
	-	5010	310m
---	---	------	------

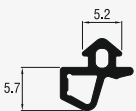
	VISTA BEST	5422	420m
---	------------	------	------

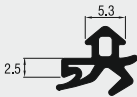
	VISTA BEST	5423	370m
--	------------	------	------

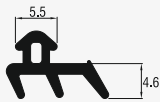
	-	5020	340m
---	---	------	------

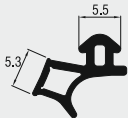
	-	5021	340m
---	---	------	------

	HOFMANN	5451	290m
---	---------	------	------

ARTEC

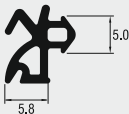
	DVU-16	5259	300m
---	--------	------	------

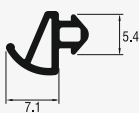
	DFI-53	5230	400m
---	--------	------	------

section отрезок	cust.ref.nr. номер клиентна	code nr. код но.	packing погонные м.
--------------------	--------------------------------	---------------------	------------------------

ASASPEN

	CC01006	5029	400m
--	---------	------	------

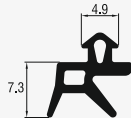
	CC01002	5107	300m
--	---------	------	------

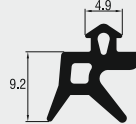
	CC01001	5110	230m
--	---------	------	------

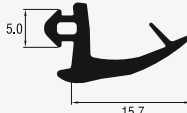
	CC01005	5108	200m
--	---------	------	------

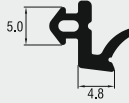
	-	5109	400m
---	---	------	------

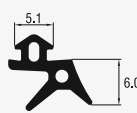
	-	5117	350m
--	---	------	------

	-	5147	400m
--	---	------	------

	CC01009	5025	400m
--	---------	------	------

	CC01010	5198	450m
--	---------	------	------

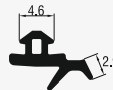
	CC01012	5210	500m
--	---------	------	------

PVC GROUP

section отрезок	cust.ref.nr. номер клиентна	code nr. код но.	packing погонные м.
--------------------	--------------------------------	---------------------	------------------------

	-	5047	326m
--	---	------	------

	-	5061	272m
--	---	------	------

	-	5192	250m
--	---	------	------

	-	5193	277m
--	---	------	------

	-	5147	333m
--	---	------	------

EUROLINE

	-	5286	306m
--	---	------	------

	-	5280	254m
--	---	------	------

EUROPEN

	-	5105	230m
--	---	------	------

	-	5106	333m
--	---	------	------

	-	5115	306m
--	---	------	------

section отрезок	cust.ref.nr. номер клиентна	code nr. код но.	packing погонные м.
--------------------	--------------------------------	---------------------	------------------------

	-	5197	242m
--	---	------	------

	-	5212	441m
--	---	------	------

	-	5280	254m
--	---	------	------

EUROPLAST

	-	5202	400m
--	---	------	------

	-	5343	350m
--	---	------	------

	-	5172	350m
--	---	------	------

	112.0500014.00	5408	300m
--	----------------	------	------

EXPROF

	D255	5372	300m
--	------	------	------

	D227	5373	400m
--	------	------	------

FILPEN

	-	5168	145m
--	---	------	------



PVC GROUP

section отрезок	cust.ref.nr. номер клиентна	code nr. код но.	packing погонные м.
	-	5169	214m
	-	5109	340m
	-	5073	272m

FIRATPEN

	-	5048	250m
	-	5047	326m
	-	5049	416m
	-	5159	230m
	-	5130	267m
	FIR-10	5351	267m
	-	5290	416m

section отрезок	cust.ref.nr. номер клиентна	code nr. код но.	packing погонные м.
--------------------	--------------------------------	---------------------	------------------------

GEALAN

	3152	5231	350m
	2149	5232	500m
	GEALAN 3152-A	5350	400m
	315390 S	5374	300m
	315290 S	5379	350m
	214990 S	5380	500m
	214990 INT	5454	500m
	315290 INT	5425	350m

GÜNELPEN

	-	5139	300m
	-	5142	333m

PVC GROUP

section отрезок	cust.ref.nr. номер клиентна	code nr. код но.	packing погонные м.
--------------------	--------------------------------	---------------------	------------------------

	INTERNOVA	5348	250m
--	-----------	------	------

	INTERNOVA	5349	350m
--	-----------	------	------

INTERPLAST A

	214990 S	5424	580m
--	----------	------	------

	315290 S	5425	370m
--	----------	------	------

KALPEN

	-	5054	238m
--	---	------	------

	-	5002	375m
--	---	------	------

	-	5055	340m
--	---	------	------

	-	5065	384m
--	---	------	------

	-	5066	170m
--	---	------	------

	-	5089	263m
--	---	------	------

section отрезок	cust.ref.nr. номер клиентна	code nr. код но.	packing погонные м.
--------------------	--------------------------------	---------------------	------------------------

	-	5056	283m
--	---	------	------

	-	5077	250m
--	---	------	------

	-	5081	187m
--	---	------	------

	-	5088	312m
--	---	------	------

	-	5298	319m
--	---	------	------

	-	5264	416m
--	---	------	------

	1255	5345	357m
--	------	------	------

	1258	5346	395m
--	------	------	------

KBE

	D04	5017	350m
--	-----	------	------

	D227	5018	400m
--	------	------	------



PVC GROUP

section отрезок	cust.ref.nr. номер клиентна	code nr. код но.	packing погонные м.
--------------------	--------------------------------	---------------------	------------------------

	D02	5183	420m
--	-----	------	------

	D255	5239	300m
--	------	------	------

	D254	5352	400m
--	------	------	------

KEBANPEN

	-	5136	312m
--	---	------	------

	-	5033	394m
--	---	------	------

	-	5016	319m
--	---	------	------

	-	5014	333m
--	---	------	------

	-	5028	250m
--	---	------	------

	-	5090	375m
--	---	------	------

KOMMERLING

	9044	5074	250m
--	------	------	------

section отрезок	cust.ref.nr. номер клиентна	code nr. код но.	packing погонные м.
--------------------	--------------------------------	---------------------	------------------------

	9040	5075	450m
--	------	------	------

	9044-A	5403	280m
--	--------	------	------

KOMPEN

	-	5070	230m
--	---	------	------

	-	5116	272m
--	---	------	------

	-	5095	200m
--	---	------	------

	-	5094	334m
--	---	------	------

	-	5071	176m
--	---	------	------

	-	5072	300m
--	---	------	------

	-	5167	267m
--	---	------	------

	-	5177	214m
--	---	------	------

PVC GROUP

section отрезок	cust.ref.nr. номер клиентна	code nr. код но.	packing погонные м.
--------------------	--------------------------------	---------------------	------------------------

	-	5181	263m
--	---	------	------

	-	5020	300m
--	---	------	------

	-	5021	300m
--	---	------	------

	-	5260	319m
--	---	------	------

	-	5076	145m
--	---	------	------

	KOM 10	5254	357m
--	--------	------	------

	-	5057	253m
--	---	------	------

	-	5059	151m
--	---	------	------

	-	5328	340m
--	---	------	------

	-	5060	210m
--	---	------	------

section отрезок	cust.ref.nr. номер клиентна	code nr. код но.	packing погонные м.
--------------------	--------------------------------	---------------------	------------------------

LG

	902	5357	460m
--	-----	------	------

	-	5358	450m
--	---	------	------

MAHJOUR

	-	5103	306m
--	---	------	------

	-	5104	348m
--	---	------	------

	-	5111	274m
--	---	------	------

	-	5165	258m
--	---	------	------

	-	5166	326m
--	---	------	------

	-	6514	60m
--	---	------	-----

MUHTELİF PVC

	DURSUNLAR	5215	176m
--	-----------	------	------



PVC GROUP

section отрезок	cust.ref.nr. номер клиентна	code nr. код но.	packing погонные м.
	7175411 00000	5219	300m
	R70000100000	5241	425m
	R70000300000	5243	344m
	R70000200000	5242	384m
	R11124800000	5268	100m
	-	5400	50m
	7199313000 00W0000	5281	500m
	7199165000 00W0000	5282	300m
	7199314000 00W0000	5283	400m

section отрезок	cust.ref.nr. номер клиентна	code nr. код но.	packing погонные м.
	7199135000 00W0000	5284	400m
PLAFEN			
	-	5233	500m
	-	5374	300m
PLASPEN			
	-	5118	300m/kutu
	-	5119	333m/kutu
	-	5120	272m/kutu
	-	5022	217m/kutu
	-	5023	357m/kutu
	-	5024	272m/kutu
PLASTMO			
	5802055	5341	270m

PVC GROUP

section отрезок	cust.ref.nr. номер клиентна	code nr. код но.	packing погонные м.
--------------------	--------------------------------	---------------------	------------------------

	680531	5342	400m
--	--------	------	------

PLUSTEK

	19161	5332	450m
--	-------	------	------

POLIPEN

	-	5118	300m
--	---	------	------

	-	5033	394m
--	---	------	------

	-	5109	340m
--	---	------	------

	-	5029	357m
--	---	------	------

PROKAL

	-	5139	300m
--	---	------	------

	-	5082	263m
--	---	------	------

	-	5084	288m
--	---	------	------

	-	5272	555m
--	---	------	------

section отрезок	cust.ref.nr. номер клиентна	code nr. код но.	packing погонные м.
--------------------	--------------------------------	---------------------	------------------------

	-	5344	83m
--	---	------	-----

PROLINE

	-	5107	272m
--	---	------	------

	-	5101	341m
--	---	------	------

	-	5207	340m
--	---	------	------

REHAU

	865010	5174	250m
--	--------	------	------

	865950	5175	450m
--	--------	------	------

	865002	5062	350m
--	--------	------	------

	-	5363	400m
--	---	------	------

	REHAU	5305	500m
--	-------	------	------

	REHAU	5306	400m
--	-------	------	------



PVC GROUP

section отрезок	cust.ref.nr. номер клиентна	code nr. код но.	packing погонные м.
--------------------	--------------------------------	---------------------	------------------------

RESMAN

	-	5302	394m
	-	5303	312m
	-	5010	277m

SALAMANDER

	414020	5233	500m 350m
	414465	5234	350m 250m
	19211	5333	300m

	414560	5368	400m
--	--------	------	------

	414020	5369	400m
--	--------	------	------

SARAY PEN

	SA-02	5245	333m
	SA-01	5246	348m

section отрезок	cust.ref.nr. номер клиентна	code nr. код но.	packing погонные м.
--------------------	--------------------------------	---------------------	------------------------

	SA-21	5110	200m
--	-------	------	------

	SA-01/B	5010	277m
--	---------	------	------

	01	5418	300m
--	----	------	------

	02	5419	270m
--	----	------	------

SCHEFFER

	-	5128	300m
--	---	------	------

	-	5187	300m
--	---	------	------

SECPEN

	-	5067	205m
--	---	------	------

	-	5068	245m
--	---	------	------

	-	5069	326m
--	---	------	------

STARPEN

	-	5190	267m
--	---	------	------

PVC GROUP

section отрезок	cust.ref.nr. номер клиентна	code nr. код но.	packing погонные м.
--------------------	--------------------------------	---------------------	------------------------

	9002	5360	250m
--	------	------	------

VEGA

	-	5139	300m
--	---	------	------

	-	5187	267m
--	---	------	------

VEKA

	112.051	5170	350m
--	---------	------	------

	112.072	5171	400m
--	---------	------	------

	112.050	5172	350m
--	---------	------	------

	112.001	5173	500m
--	---------	------	------

	112.253	5202	400m 300m
--	---------	------	--------------

	112.263	5208	350m
--	---------	------	------

	112.264	5209	450m
--	---------	------	------

section отрезок	cust.ref.nr. номер клиентна	code nr. код но.	packing погонные м.
--------------------	--------------------------------	---------------------	------------------------

	112.254	5222	400m 300m
--	---------	------	--------------

	-	5296	400m 300m
--	---	------	--------------

	-	5343	350m 300m
--	---	------	--------------

VISTA BEST

	VISTA BEST 01	5422	350m
--	---------------	------	------

	VISTA BEST 02	5423	330m
--	---------------	------	------

WELTPLAST

	WD-035	5062	350m
--	--------	------	------

	550032	5006	550m
--	--------	------	------

	WD-038	5075	450m
--	--------	------	------

	700036	5236	280m
--	--------	------	------

	865950	5175	450m
--	--------	------	------



PVC GROUP

section отрезок	cust.ref.nr. номер клиентна	code nr. код но.	packing погонные м.
--------------------	--------------------------------	---------------------	------------------------

	WD-034	5371	370m
---	--------	------	------

WINAPEX

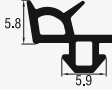
	-	5286	306m
---	---	------	------

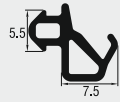
	-	5295	326m
---	---	------	------

WINDOLINE

	-	5112	263m
---	---	------	------

	-	5113	283m
--	---	------	------

WINTEC ROMANYA

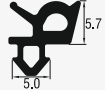
	865002WIN	5427	350m
---	-----------	------	------

	214990WIN	5428	600m
---	-----------	------	------

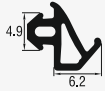
	100200WIN	5429	400m
---	-----------	------	------

	429340WIN	5430	400m
---	-----------	------	------

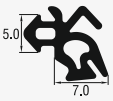
	459925WIN	5431	300m
---	-----------	------	------

section отрезок	cust.ref.nr. номер клиентна	code nr. код но.	packing погонные м.
--------------------	--------------------------------	---------------------	------------------------

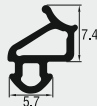
	112254WIN	5432	400m
--	-----------	------	------

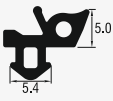
	315290WIN	5433	350m
--	-----------	------	------

	112253WIN	5202	400m
--	-----------	------	------

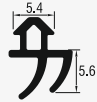
	864952WIN	5363	450m
--	-----------	------	------

WINTECH

	-	5394	400m
---	---	------	------

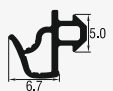
	-	5395	450m
--	---	------	------

WORLDPEN

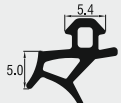
	-	5328	263m
--	---	------	------

	-	5139	300m
--	---	------	------

Y. TURKUAZ

	-	5178	500m
--	---	------	------

	-	5179	348m
--	---	------	------



ALUMINIUM GROUP

section	cust.ref.nr.	code nr.	packing
отрезок	номер клиентна	КОД НО.	погонные м.

AÇI CEPHE SİSTEMLERİ

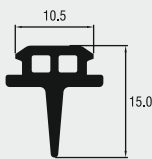
	E/F - 02	6629	182m
---	----------	------	------

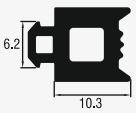
	E/F - 03	6630	230m
---	----------	------	------

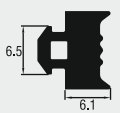
	E/F - 04	6631	180m
---	----------	------	------

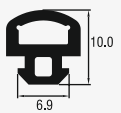
	E/F - 01	6632	220m
--	----------	------	------

ADEN ALM.

	-	7377	120m
---	---	------	------

ADVANCED TECH.

	-	-	-
---	---	---	---

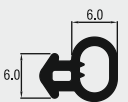
	-	-	-
---	---	---	---

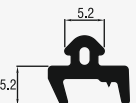
	-	-	-
---	---	---	---

AGRISOVGAZ

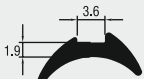
	032NZQU25001 (G002D)	6933	400m
---	----------------------	------	------

section	cust.ref.nr.	code nr.	packing
отрезок	номер клиентна	КОД НО.	погонные м.

	032NZQU25002 (G003D)	6934	270m
--	----------------------	------	------

	032NZQU25003 (G004D)	6935	200m
--	----------------------	------	------

	032NZQU25006 (G007D)	6936	300m
--	----------------------	------	------

	032NZQU25010 (G001D)	6937	650m
--	----------------------	------	------

	032NZQU34012 (G070D)	6938	240m
---	----------------------	------	------

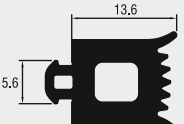
	032NZQU34002 (G050D)	7006	120m
--	----------------------	------	------

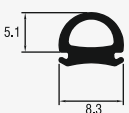
	AAZQ051	7075	450m
--	---------	------	------

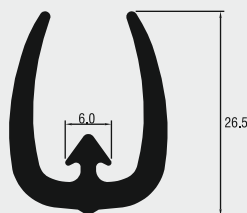
	BAZR013	7076	60m
--	---------	------	-----

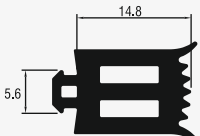
	032NZQU34008 (G073D)	7077	100m
--	----------------------	------	------



ALUMINIUM GROUP

section отрезок	cust.ref.nr. номер клиентна	code nr. код но.	packing погонные м.
--------------------	--------------------------------	---------------------	------------------------

	032NZQU34024 (Y022)	7078	120m
--	------------------------	------	------

	032NZQU22002 (G026D)	7096	240m
--	-------------------------	------	------

	032NZQU34005 (G065D)	7097	120m
--	-------------------------	------	------

	032NZQU34007 (G067D)	7098	240m
--	-------------------------	------	------

	032NZQU34028 (Y019)	7099	280m
--	------------------------	------	------

	032NZQU25014 (Y001)	7120	130m
--	------------------------	------	------

	032NZQU25016 (Y003)	7121	120m
--	------------------------	------	------

	032NZQU34023 (Y021)	7122	150m
--	------------------------	------	------

	032NZQU34025 (Y023)	7123	100m
--	------------------------	------	------

section отрезок	cust.ref.nr. номер клиентна	code nr. код но.	packing погонные м.
--------------------	--------------------------------	---------------------	------------------------

	032NZQU34027 (Y025)	7124	80m
--	------------------------	------	-----

	032NZQU25007 (G017D)	7125	500m
--	-------------------------	------	------

	AAZQ111	7185	100m
--	---------	------	------

	032NZQU25019 (Y006)	7186	40m
--	------------------------	------	-----

	AAZQ114	7187	100m
--	---------	------	------

	032NZQU34062 (Y088)	7188	50m
--	------------------------	------	-----

	AAZQ011	7207	130m
--	---------	------	------

	BAZR014	7208	110m
--	---------	------	------

	032NZQU25005 (G012D)	7223	90m
--	-------------------------	------	-----

	032NZQU25018 (Y005)	7224	400m
--	------------------------	------	------

ALUMINIUM GROUP

section отрезок	cust.ref.nr. номер клиентна	code nr. КОД НО.	packing погонные м.
--------------------	--------------------------------	---------------------	------------------------

	032NZQU34022 (Y020)	7225	180m
---	------------------------	------	------

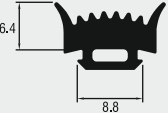
	G 010D	7256	120m
---	--------	------	------

	032NZQU25015 (Y002)	7328	150m
---	------------------------	------	------

	032NZQU34026 (Y024)	7398	90m
---	------------------------	------	-----

AKEL METAL

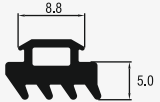
	-	5728	205m
--	---	------	------

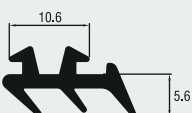
	-	5572	176m
---	---	------	------

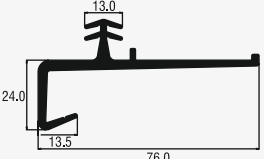
	-	5602	30m
---	---	------	-----

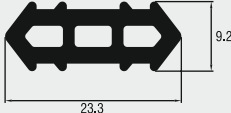
	-	5662	94m
---	---	------	-----

AKFA

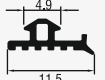
	-	7126	600m
---	---	------	------

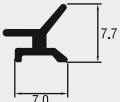
	-	7127	600m
---	---	------	------

section отрезок	cust.ref.nr. номер клиентна	code nr. КОД НО.	packing погонные м.
--------------------	--------------------------------	---------------------	------------------------

AKOTHERM

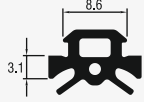
	2104	7353	200m
--	------	------	------

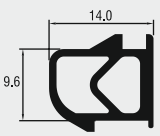
	SKF01	7354	150m
--	-------	------	------

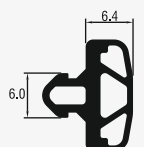
	CFT01	7355	160m
--	-------	------	------

	IFT04	7356	180m
--	-------	------	------

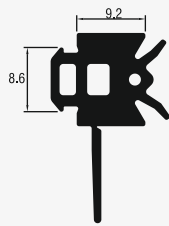
	2110	7393	80m
---	------	------	-----

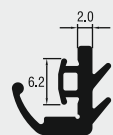
	2291	7409	50m
--	------	------	-----

AKPA

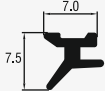
	-	5939	345m
--	---	------	------

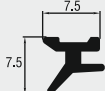
	-	5940	333m
--	---	------	------

	DCF30	5965	405m
--	-------	------	------



ALUMINIUM GROUP

section отрезок	cust.ref.nr. номер клиентна	code nr. КОД НО.	packing погонные м.
--------------------	--------------------------------	---------------------	------------------------

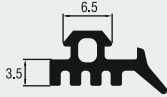
	AFC 101	6875	241m
---	---------	------	------

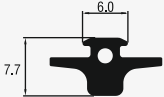
	AFC 107	6550	238m
---	---------	------	------

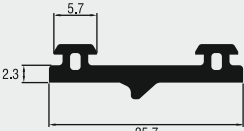
	AFC 114	6549	144m
---	---------	------	------

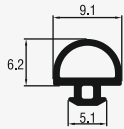
	AFC 113	5968	405m
---	---------	------	------

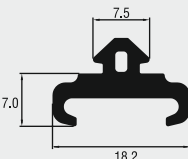
	AFC 109	6572	143m
--	---------	------	------

	AFW 904	6627	87m
---	---------	------	-----

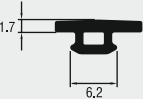
	-	7379	385m
---	---	------	------

ALPROF

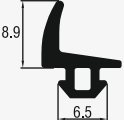
	AP001	6709	261m
---	-------	------	------

	AP003	6710	96m
---	-------	------	-----

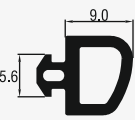
	AP004	6711	207m
---	-------	------	------

section отрезок	cust.ref.nr. номер клиентна	code nr. КОД НО.	packing погонные м.
--------------------	--------------------------------	---------------------	------------------------

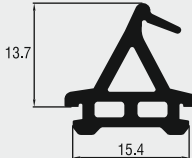
	AP005	5712	120m
--	-------	------	------

	AP002	5713	139m
--	-------	------	------

	-	5593	277m 425m
--	---	------	--------------

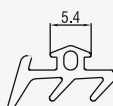
	-	5592	227m 347m
--	---	------	--------------

	-	5768	86m
---	---	------	-----

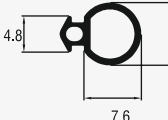
	-	5585	485m
--	---	------	------

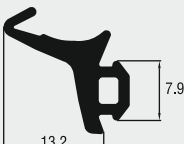
	-	5584	160m
--	---	------	------

	-	5609	276m
--	---	------	------

	AP009	6851	162m
--	-------	------	------

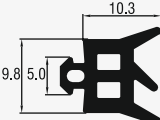
	AP11	6862	162m
--	------	------	------

ALUMINIUM GROUP

section	cust.ref.nr.	code nr.	packing
отрезок	номер клиентна	КОД НО.	погонные м.

section	cust.ref.nr.	code nr.	packing
отрезок	номер клиентна	КОД НО.	погонные м.

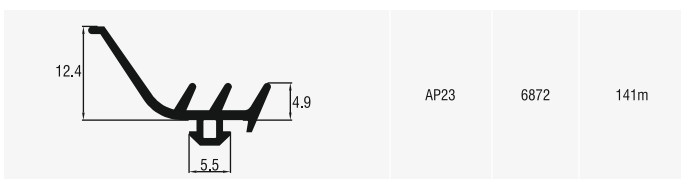
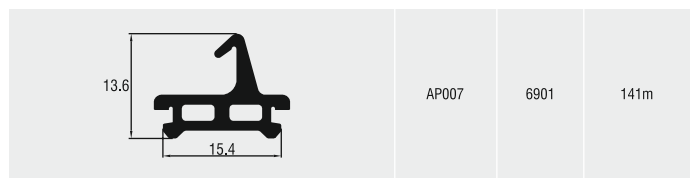
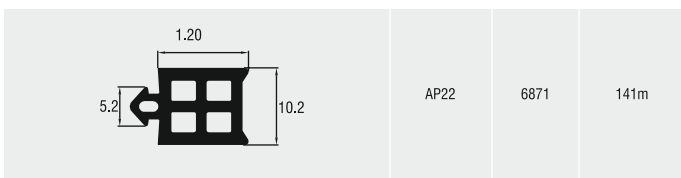
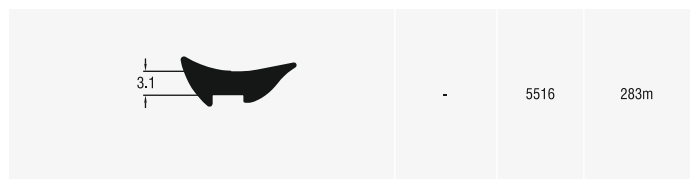
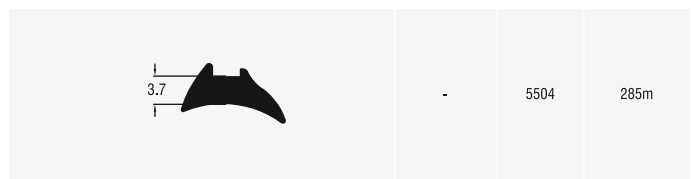
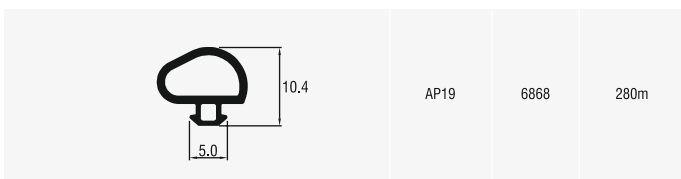
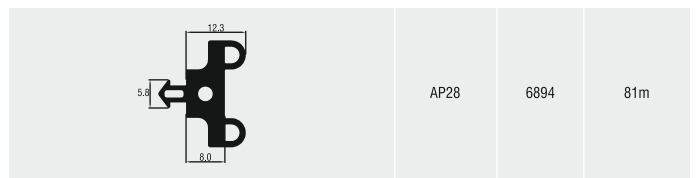
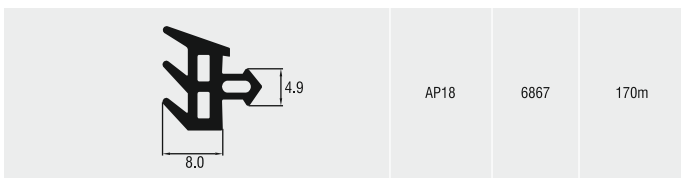
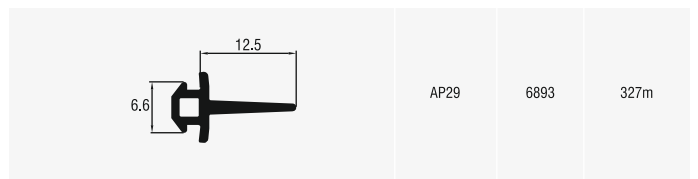
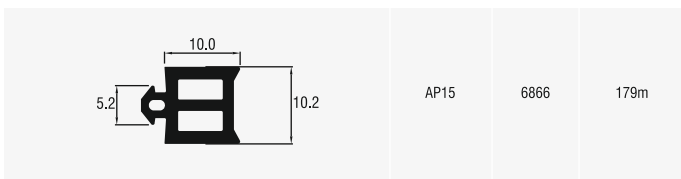
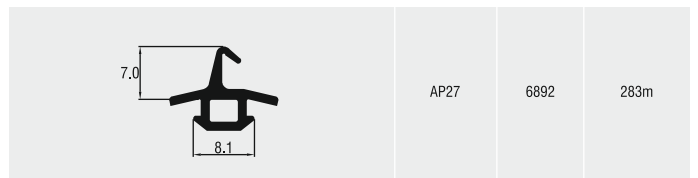
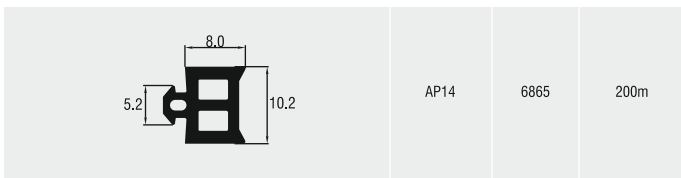
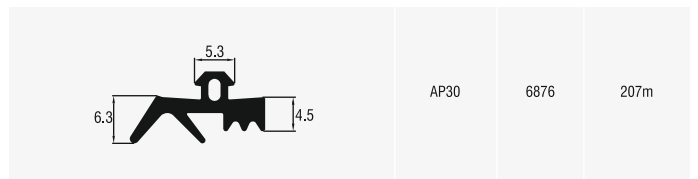
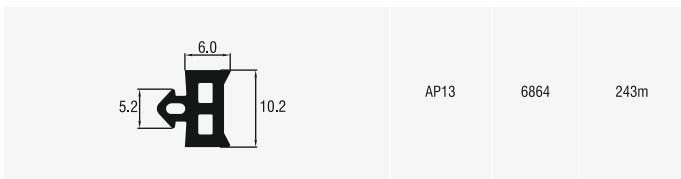
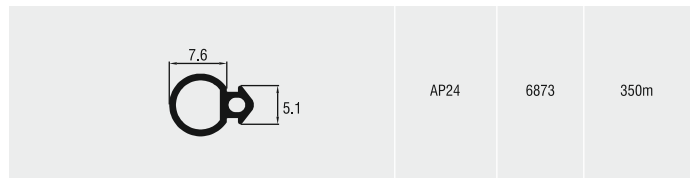

ALUMINIUM GROUP

section отрезок	cust.ref.nr. номер клиентна	code nr. КОД НО.	packing погонные м.
--------------------	--------------------------------	---------------------	------------------------

	-	5701	394m
--	---	------	------

	-	5702	104m
--	---	------	------

	-	5703	348m
--	---	------	------

	MG411	5517	150m
--	-------	------	------

	44 F 43	5518	250m
--	---------	------	------

	44 F 46	5526	500m
--	---------	------	------

	44 F 02	5501	120m
--	---------	------	------

	44 F 31 46 A 04	5503	300m
--	--------------------	------	------

	5CG72	7237	420m
--	-------	------	------

	5CG73	7238	120m
--	-------	------	------

section отрезок	cust.ref.nr. номер клиентна	code nr. КОД НО.	packing погонные м.
--------------------	--------------------------------	---------------------	------------------------

	5CG74	7239	270m
--	-------	------	------

	-	7319	250m
--	---	------	------

	-	5543	190m
--	---	------	------

	-	5544	150m
--	---	------	------

	-	5545	120m
--	---	------	------

ALUMIN TECHNO

	FRK07	7065	550m
--	-------	------	------

	FRK28	6571	200m
--	-------	------	------

	FRK52	9348	2000adet / kutu
--	-------	------	--------------------

ALUTRADE

	44 F 76	5502	400m
--	---------	------	------



ALUMINIUM GROUP

section отрезок	cust.ref.nr. номер клиентна	code nr. КОД НО.	packing погонные м.
--------------------	--------------------------------	---------------------	------------------------

	Mg 411	5517	150m
---	--------	------	------

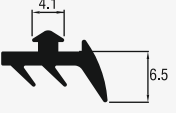
	44 F 43	5518	250m
---	---------	------	------

	44 F 46	5526	500m
---	---------	------	------

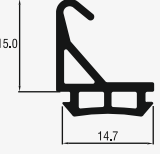
	44 F 02	5501	120m
---	---------	------	------

	44 F 31 46 A 04	5503	300m
--	--------------------	------	------

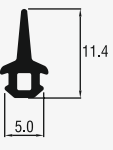
	5CG72	7237	420m
---	-------	------	------

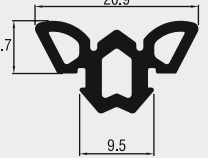
	5CG73	7238	120m
---	-------	------	------

	5CG74	7239	270m
---	-------	------	------

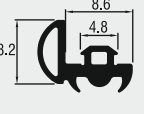
	-	7319	250m
---	---	------	------

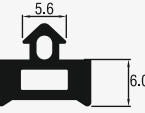
	-	5543	190m
---	---	------	------

section отрезок	cust.ref.nr. номер клиентна	code nr. КОД НО.	packing погонные м.
--------------------	--------------------------------	---------------------	------------------------

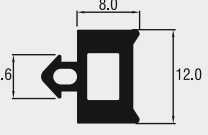
	-	5544	150m
--	---	------	------

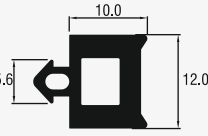
	-	5545	120m
--	---	------	------

ALUWINDOOR

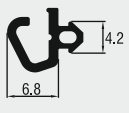
	WDE 201	5701	450m
--	---------	------	------

	WDF-204	5503	300m
--	---------	------	------

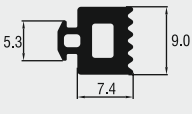
	WDF-207	5974	220m
---	---------	------	------

	WDF-208	5973	380m
--	---------	------	------

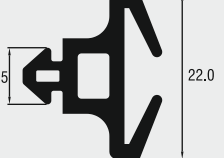
	WDF-211	5981	100m
--	---------	------	------

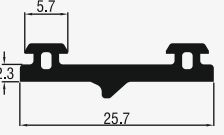
	WDF-212	6549	160m
--	---------	------	------

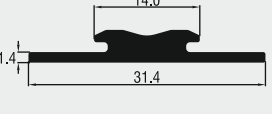
	WDF 229	5976	160m
--	---------	------	------

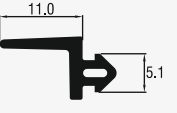
	WDF-210	5932	300m
--	---------	------	------



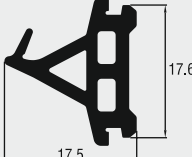

ALUMINIUM GROUP

section отрезок	cust.ref.nr. номер клиентна	code nr. КОД НО.	packing погонные м.
--------------------	--------------------------------	---------------------	------------------------

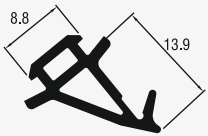
	WDF 217	6513	110m
---	---------	------	------

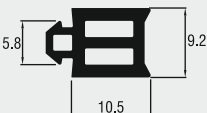
	WDF 205	6902	170m
---	---------	------	------

	WDF 209	6903	170m
---	---------	------	------

	WDF 206	6924	260m
---	---------	------	------

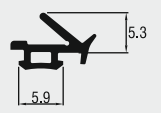
	WDF 202	6925	450m
--	---------	------	------

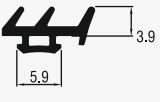
	WDF 203	6926	400m
---	---------	------	------

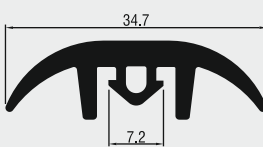
	WDF 232	6927	90m
---	---------	------	-----

AMS

	-	5999	150m
---	---	------	------

ARABIAN

	9028/14	6542	600m
---	---------	------	------

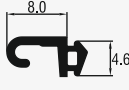
	905803	6543	500m
---	--------	------	------

section отрезок	cust.ref.nr. номер клиентна	code nr. КОД НО.	packing погонные м.
--------------------	--------------------------------	---------------------	------------------------

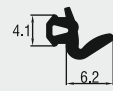
	9029/14	6544	500m
--	---------	------	------

ARABIAN ALM.

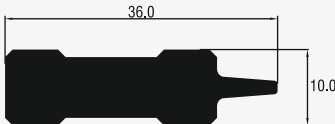
	5721	7090	500 Ad/Kutu
--	------	------	-------------

	5722	7091	500 Ad/Kutu
--	------	------	-------------

	5723	7109	1500 Ad/Kutu
--	------	------	--------------

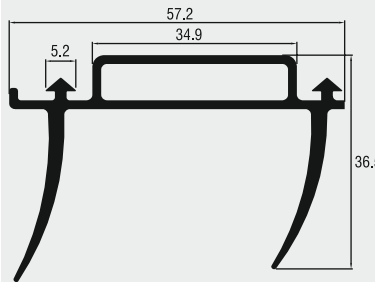
	5709	7110	30 Ad/Kutu
---	------	------	------------

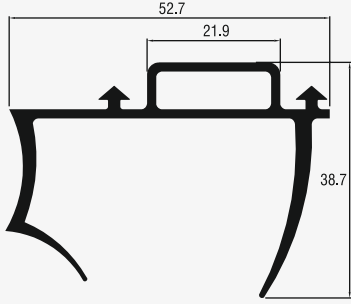
	5710	7111	30 Ad/Kutu
--	------	------	------------

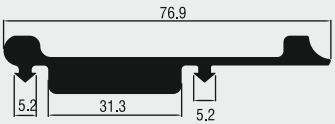
	5719	7132	30 Ad/Kutu
--	------	------	------------

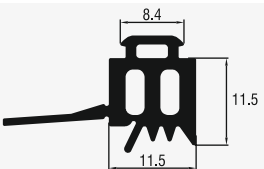
	750110	6694	90m
--	--------	------	-----



ALUMINIUM GROUP

section отрезок	cust.ref.nr. номер клиентна	code nr. КОД НО.	packing погонные м.
--------------------	--------------------------------	---------------------	------------------------

	750214	7232	100m
--	--------	------	------

	750114	7235	50m
--	--------	------	-----

ARDEN

	01	7200	340m
--	----	------	------

	02	7201	220m
--	----	------	------

	03	7202	220m
--	----	------	------

	04	7203	280m
--	----	------	------

	05	7204	250m
--	----	------	------

	06	7205	100m
--	----	------	------

	07	7227	100m
--	----	------	------

section отрезок	cust.ref.nr. номер клиентна	code nr. КОД НО.	packing погонные м.
--------------------	--------------------------------	---------------------	------------------------

ARHİTRAVİ

	-	5782	180m
--	---	------	------

ARIA

	-	5010	314m
--	---	------	------

	-	5376	320m
--	---	------	------

ASAŞ ALM.

	50EF10	5734	340m
--	--------	------	------

	50EF30	5735	566m
--	--------	------	------

	50EF40	5736	485m
--	--------	------	------

	50EF20	5737	274m
--	--------	------	------

	50EF50	5738	109m
--	--------	------	------

	50EF21	5503	369m
--	--------	------	------

	50GF40	5721	144m
--	--------	------	------



ALUMINIUM GROUP

section отрезок	cust.ref.nr. номер клиентна	code nr. КОД НО.	packing погонные м.
--------------------	--------------------------------	---------------------	------------------------

	50GC05	5749	396m
---	--------	------	------

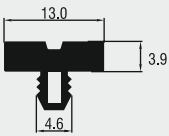
	50GC01	5750	221m
---	--------	------	------

	50GC02	5751	284m
---	--------	------	------

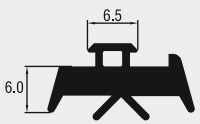
	50GC04	5752	143m
---	--------	------	------

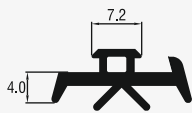
	50GC03	5753	218m
--	--------	------	------

	S 56-ICF	5593	425m
---	----------	------	------

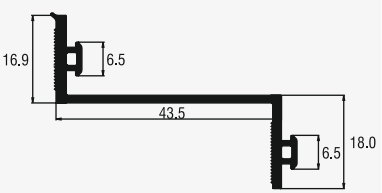
	50GC06	5754	91m
---	--------	------	-----

	S 56-DCF	5592	347m
---	----------	------	------

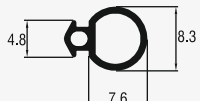
	S 56-KIBF	5585	424m
---	-----------	------	------

section отрезок	cust.ref.nr. номер клиентна	code nr. КОД НО.	packing погонные м.
--------------------	--------------------------------	---------------------	------------------------

	S 56-KDBF	5610	355m
--	-----------	------	------

	-	5912	170m
--	---	------	------

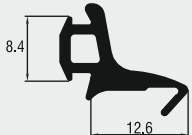
	S 56-DBF	5709	189m
--	----------	------	------

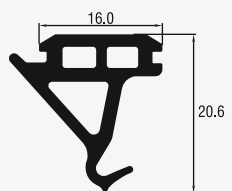
	-	5964	107m
--	---	------	------

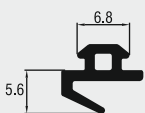
	-	6509	370m
--	---	------	------

	-	6510	194m
--	---	------	------

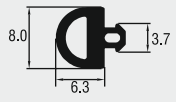
	-	6511	378m
--	---	------	------

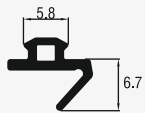
	01.18.05	6536	415m
--	----------	------	------

	01.17.04	6537	370m
--	----------	------	------

ALUMINIUM GROUP

section	cust.ref.nr.	code nr.	packing
отрезок	номер клиентна	КОД НО.	погонные м.

section	cust.ref.nr.	code nr.	packing
отрезок	номер клиентна	КОД НО.	погонные м.

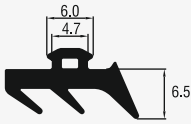
	01.16.02	6538	189m
---	----------	------	------

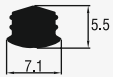
	01.19.14	6583	436m
--	----------	------	------

	01.17.03	6539	340m
---	----------	------	------

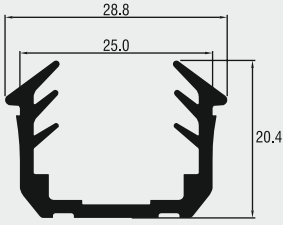
	01.16.04	2096	78m
--	----------	------	-----

	01.17.05	6540	266m
---	----------	------	------

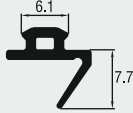
	01.18.03	6541	378m
---	----------	------	------

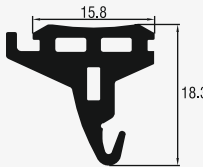
	RWT 55 001	6617	99m
--	------------	------	-----

	01.19.05	668	103m
--	----------	-----	------

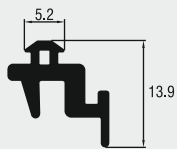
	01 20 02	6619	204m
---	----------	------	------

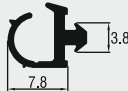
	01.18.04	6548	415m
---	----------	------	------

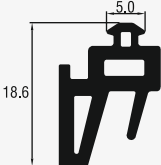
	01 20 03	6620	120m
--	----------	------	------

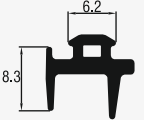
	01.18.08	6552	265m
---	----------	------	------

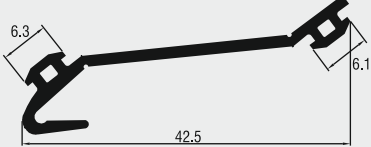
	01 18 10	6621	120m
--	----------	------	------

	01.18.09	6553	72m
---	----------	------	-----

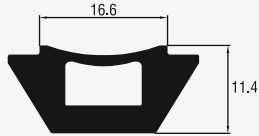
	01 18 11	6628	82m
--	----------	------	-----

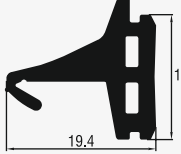
	01.19.05 (TPE)	6546	119m
---	----------------	------	------

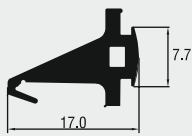
	01.08.12	6640	160m
--	----------	------	------

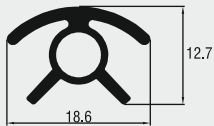
	01.07.09	6580	169m
---	----------	------	------

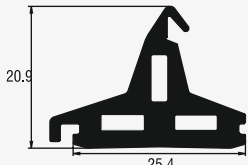
	01.19.13	6642	65m
--	----------	------	-----



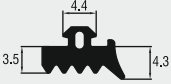

ALUMINIUM GROUP

section	cust.ref.nr.	code nr.	packing
отрезок	номер клиентна	КОД НО.	погонные м.

	REG013	6949	350m
---	--------	------	------

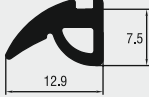
	REG014	6950	330m
---	--------	------	------

	REG015	6951	240m
---	--------	------	------

	REG016	6952	200m
---	--------	------	------

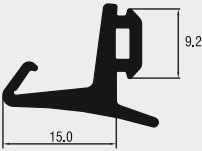
	REG022	6953	120m
--	--------	------	------

	REG023	7080	520m
---	--------	------	------

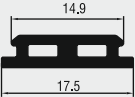
	REG041	7081	250m
---	--------	------	------

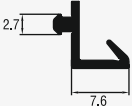
	REG042	7082	550m
---	--------	------	------

	REG043	7083	680m
---	--------	------	------

	REG044	7084	140m
---	--------	------	------

section	cust.ref.nr.	code nr.	packing
отрезок	номер клиентна	КОД НО.	погонные м.

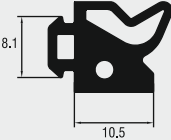
	REG026	7085	120m
--	--------	------	------

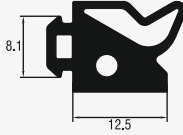
	REG027	7086	100m
--	--------	------	------

	REG010	7087	140m
--	--------	------	------

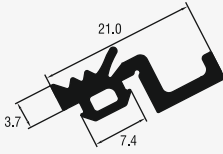
	REG030	7395	150m
--	--------	------	------

REAYNERS

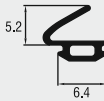
	08A9075	6877	600m
---	---------	------	------

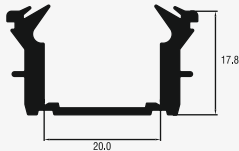
	080.9020.SY	2106	70m
--	-------------	------	-----

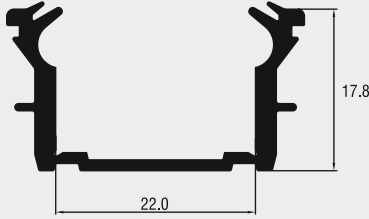
	BF.RY22.SY	2111	90m
--	------------	------	-----

RENOPLAN

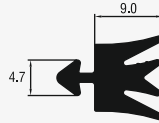
	03	6656	100m
--	----	------	------

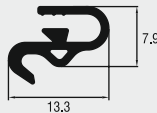
	04	6657	250m
--	----	------	------



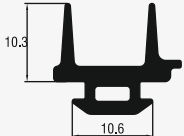

ALUMINIUM GROUP

section отрезок	cust.ref.nr. номер клиентна	code nr. КОД НО.	packing погонные м.
--------------------	--------------------------------	---------------------	------------------------

	S-113	5762	150m
---	-------	------	------

	-	5853	238m
---	---	------	------

	-	5854	277m
---	---	------	------

	EP3	5889	238m
---	-----	------	------

	EP4	5890	440m
--	-----	------	------

	-	6748	93m
---	---	------	-----

SARAYDÖKÜM

	EPIL5-3	5503	370m
---	---------	------	------

	EPIL5-4	5504	270m
---	---------	------	------

	EPIL5-5	5505	270m
---	---------	------	------

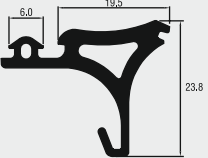
	-	5576	60m
---	---	------	-----

section отрезок	cust.ref.nr. номер клиентна	code nr. КОД НО.	packing погонные м.
--------------------	--------------------------------	---------------------	------------------------

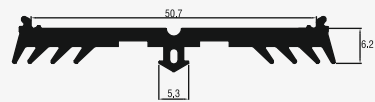
	EPIL04	5577	70m
--	--------	------	-----

	EPIL06	5578	120m
--	--------	------	------

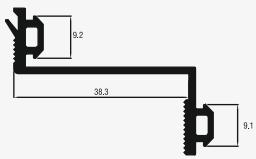
	EPIL02	5579	80m
--	--------	------	-----

	EPIL01	5580	320m
--	--------	------	------

	EPIL27	5599	420m
---	--------	------	------

	EPIL8	5614	450m
--	-------	------	------

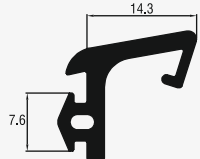
	-	5615	120m
--	---	------	------

	EPIL3	5634	550m
--	-------	------	------

	EPIL07	5635	800m
--	--------	------	------

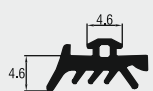
	EPIL26	5651	400m
--	--------	------	------



ALUMINIUM GROUP

section отрезок	cust.ref.nr. номер клиентна	code nr. КОД НО.	packing погонные м.
--------------------	--------------------------------	---------------------	------------------------

	EPIL5-2	5686	400m
---	---------	------	------

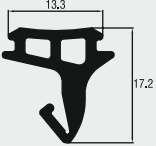
	EPIL17	5706	140m
---	--------	------	------

	EPIL16	5707	190m
---	--------	------	------

	EPIL15	5708	200m
---	--------	------	------

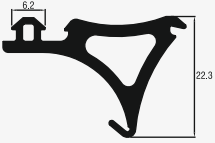
	EPIL18	5719	70m
--	--------	------	-----

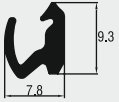
	EPIL61	5786	380m
---	--------	------	------

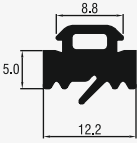
	EPIL1-5	5822	180m
---	---------	------	------

	EPIL1-3	5823	290m
---	---------	------	------

	EPIL62	5832	450m
---	--------	------	------

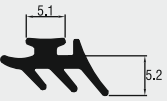
	EPIL82	5866	370m
---	--------	------	------

section отрезок	cust.ref.nr. номер клиентна	code nr. КОД НО.	packing погонные м.
--------------------	--------------------------------	---------------------	------------------------

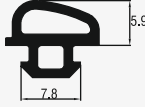
	EPIL31	5942	250m
--	--------	------	------

	EPIL33	5943	100m
--	--------	------	------

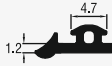
	EPIL44	5947	650m
--	--------	------	------

	EPIL10	5948	84m
--	--------	------	-----

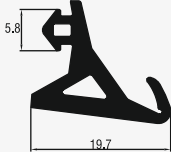
	EPIL9	5949	120m
---	-------	------	------

	EPIL28	5952	75m
--	--------	------	-----

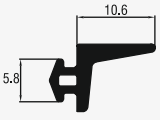
	EPIL54	5956	320m
--	--------	------	------

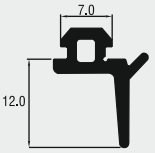
	EPIL52	5957	240m
--	--------	------	------

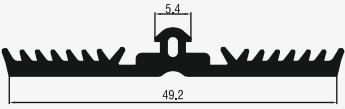
	EPIL37	5959	90m
--	--------	------	-----

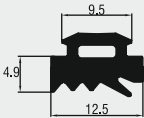
	EPIL106	5961	200m
--	---------	------	------

ALUMINIUM GROUP

section	cust.ref.nr.	code nr.	packing
отрезок	номер клиентна	КОД НО.	погонные м.

section	cust.ref.nr.	code nr.	packing
отрезок	номер клиентна	КОД НО.	погонные м.

	EPIL110	5962	160m
--	---------	------	------

	EPIL89	7041	90m
--	--------	------	-----

	EPIL210	5963	160m
--	---------	------	------

	EPIL86	7042	450m
--	--------	------	------

	EPIL105	5970	110m
--	---------	------	------

	EPIL90	7043	190m
--	--------	------	------

	-	9302	1000adet
--	---	------	----------

	EPIL94	7044	350m
--	--------	------	------

	EPIL91	6994	440m
--	--------	------	------

	EPIL54-U	6606	280m
--	----------	------	------

	EPIL40	7248	80m
--	--------	------	-----

	EPIL-34	6918	150m
--	---------	------	------

	EPIL49	7249	200m
--	--------	------	------

	EPIL42	7074	130m
--	--------	------	------

	EPIL55	7254	600m
--	--------	------	------

	EPIL85	7038	250m
--	--------	------	------

	EPIL87	7037	100m
--	--------	------	------

	EPIL84	7039	150m
--	--------	------	------

	EPIL88	7040	460m
--	--------	------	------



ALUMINIUM GROUP

section отрезок	cust.ref.nr. номер клиентна	code nr. КОД НО.	packing погонные м.
--------------------	--------------------------------	---------------------	------------------------

	WF-60.2003	6874	35m
--	------------	------	-----

	DI2021	6879	60m
--	--------	------	-----

STIMEX

	SD4000	6655	100m
--	--------	------	------

	BL125	6278	150m
--	-------	------	------

TALISMAN

	UP1	6670	90m
--	-----	------	-----

	UP2	6671	45m
--	-----	------	-----

	UP3	6672	45m
--	-----	------	-----

TASHCO

	472	7016	330m
--	-----	------	------

	471	7017	350m
--	-----	------	------

	473	7018	130m
--	-----	------	------

section отрезок	cust.ref.nr. номер клиентна	code nr. КОД НО.	packing погонные м.
--------------------	--------------------------------	---------------------	------------------------

	814	7019	100adet / kutu
--	-----	------	-------------------

TATPROF

	TNY007MM	6955	170m
--	----------	------	------

	T209-5	6956	200m
--	--------	------	------

	TNY002MM	6957	170m
--	----------	------	------

	TNY6002	6958	120m
--	---------	------	------

	TNY6001	6959	250m
--	---------	------	------

	R2.001	6960	60m
--	--------	------	-----

	TNY004MM	6961	270m
--	----------	------	------

	TNY001	6973	200m
--	--------	------	------

	TNY003	6974	350m
--	--------	------	------



ENDÜSTRİYEL GROUP

section отрезок	cust.ref.nr. номер клиентна	code nr. код но.	packing погонные м.
--------------------	--------------------------------	---------------------	------------------------

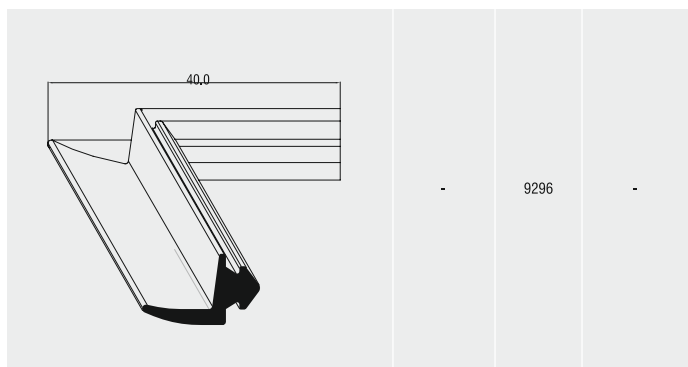

-	9296	-
---	------	---

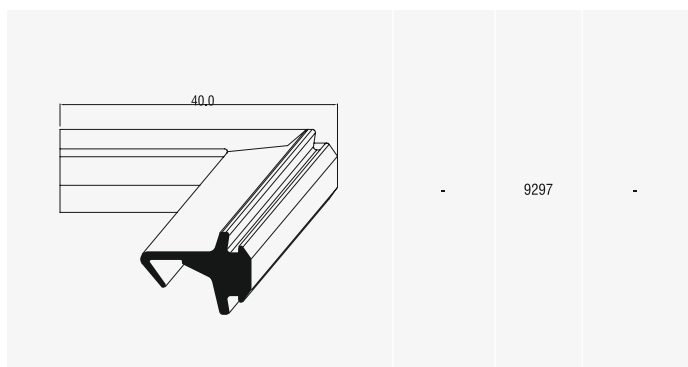

-	9297	-
---	------	---

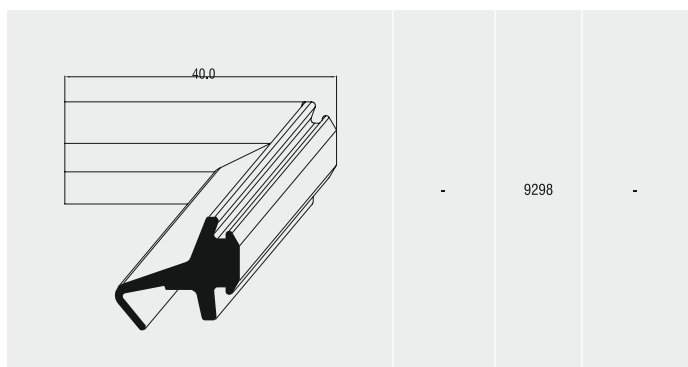

-	9298	-
---	------	---

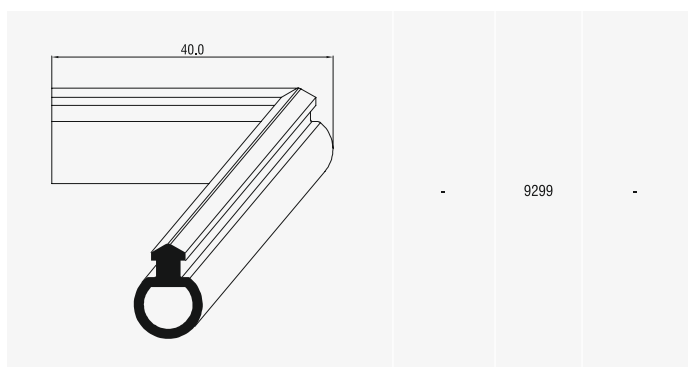

-	9299	-
---	------	---

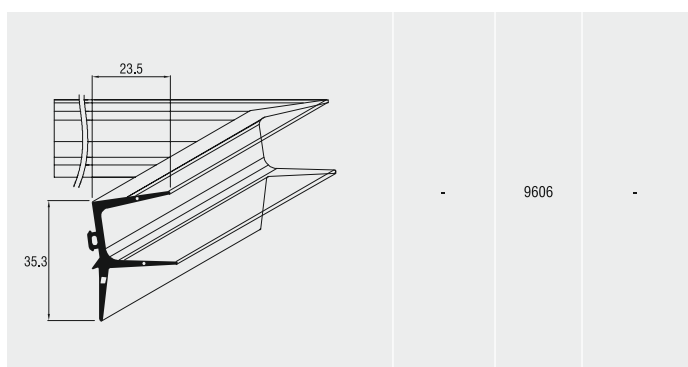

-	9606	-
---	------	---

section отрезок	cust.ref.nr. номер клиентна	code nr. код но.	packing погонные м.
--------------------	--------------------------------	---------------------	------------------------

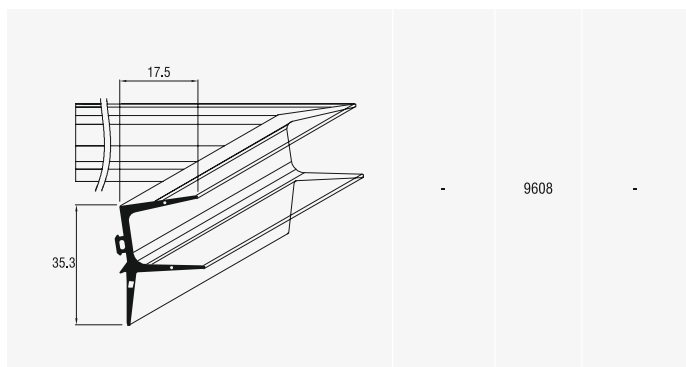

-	9608	-
---	------	---

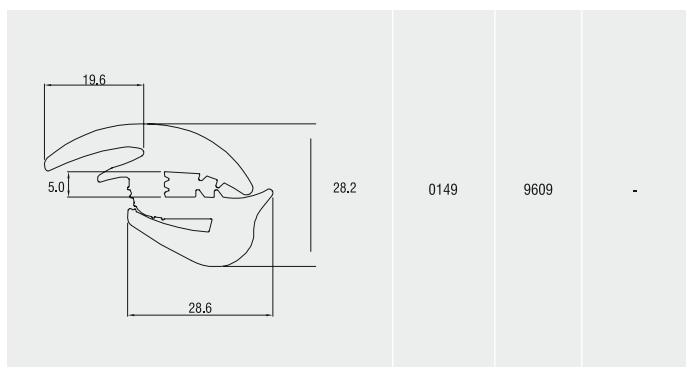

0149	9609	-
------	------	---

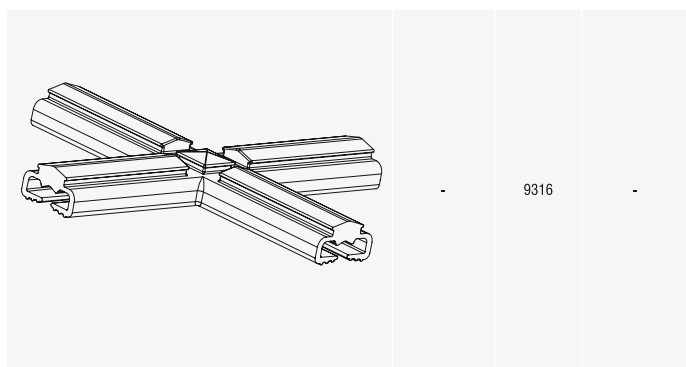

-	9316	-
---	------	---

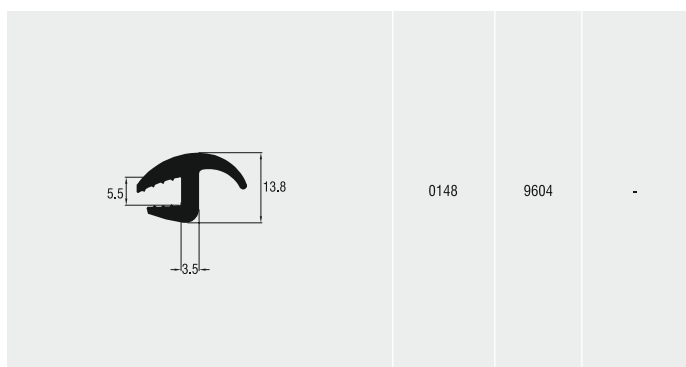

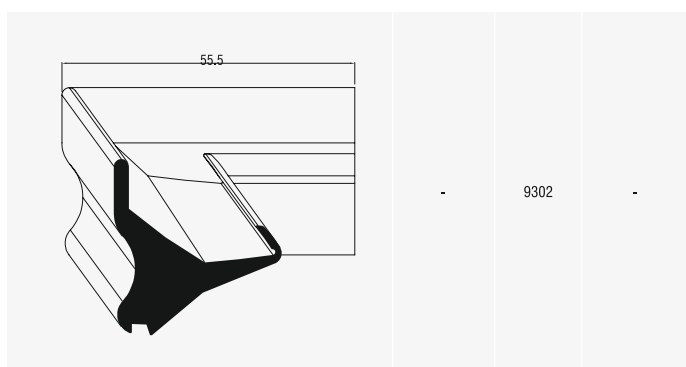

0148	9604	-
------	------	---

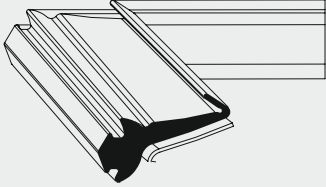
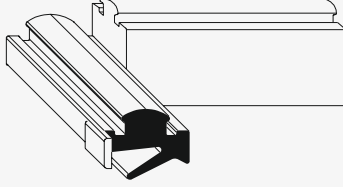
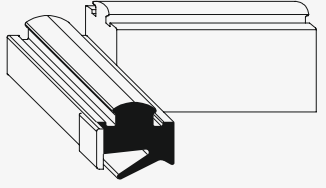
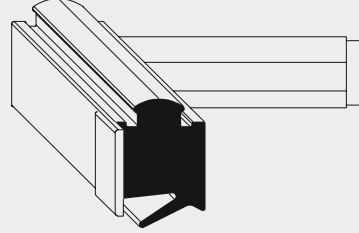
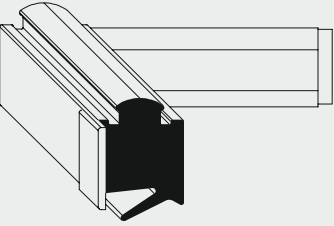

-	9302	-
---	------	---

ENDÜSTRİYEL GROUP

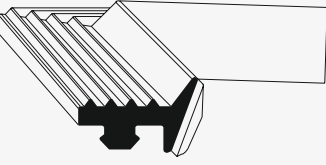
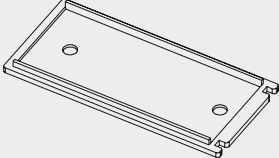
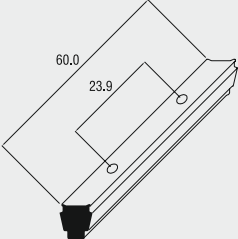
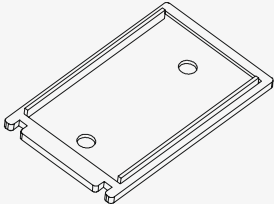
section отрезок	cust.ref.nr. номер клиентна	code nr. код но.	packing погонные м.	section отрезок	cust.ref.nr. номер клиентна	code nr. код но.	packing погонные м.
	-	9303	-		-	9307	-
	-	9304	-		-	9307	-
	-	9304	-		0535	-	-
	-	9305	-		-	9308	-
	-	9306	-		-	9309	-

section отрезок	cust.ref.nr. номер клиентна	code nr. код но.	packing погонные м.
--------------------	--------------------------------	---------------------	------------------------

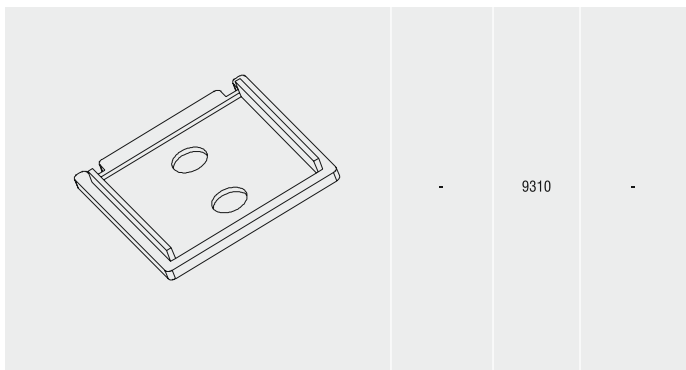

-	9310	-
---	------	---

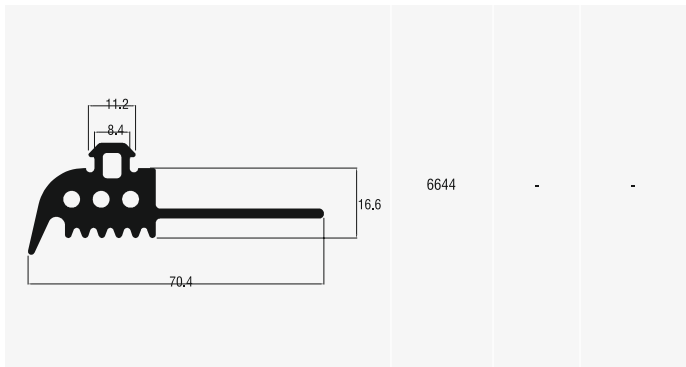

6644	-	-
------	---	---

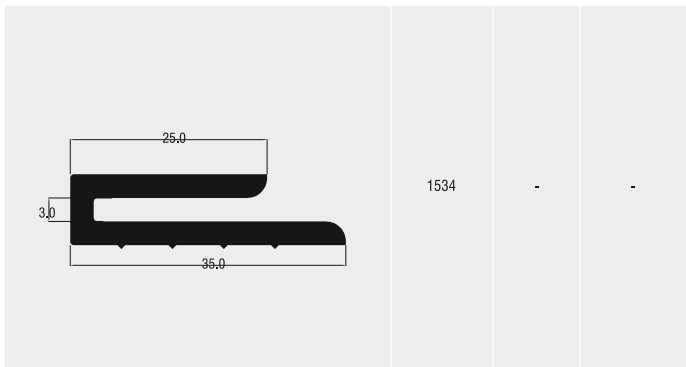

1534	-	-
------	---	---

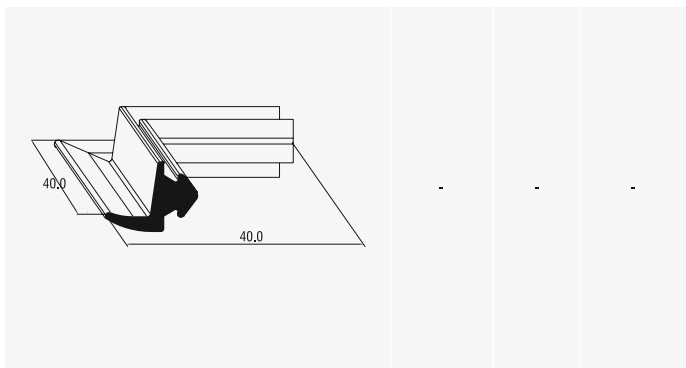

-	-	-
---	---	---

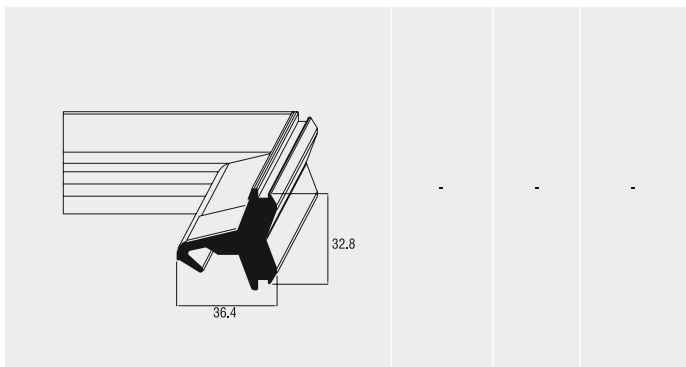

-	-	-
---	---	---

section отрезок	cust.ref.nr. номер клиентна	code nr. код но.	packing погонные м.
--------------------	--------------------------------	---------------------	------------------------



-	-	-
---	---	---

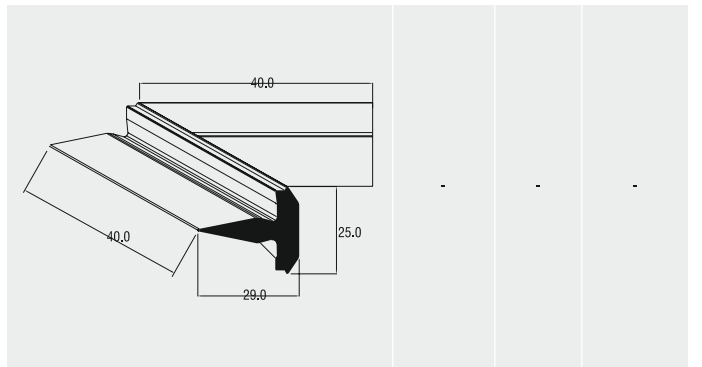

-	-	-
---	---	---

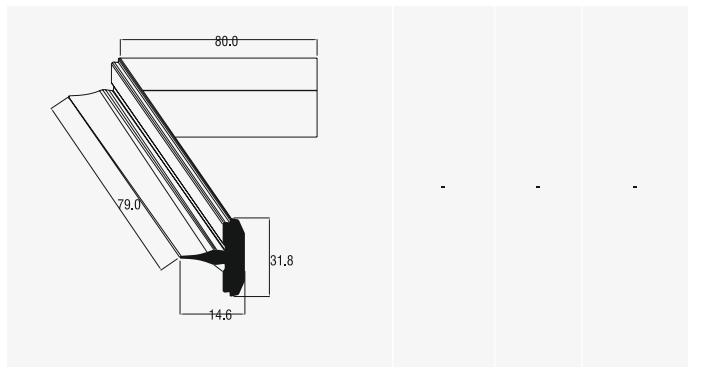

-	-	-
---	---	---

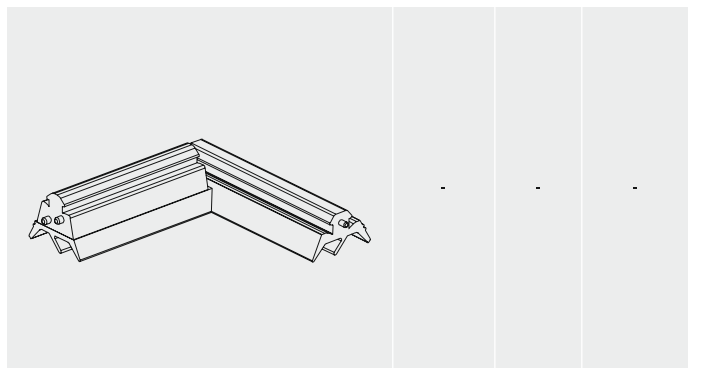

-	-	-
---	---	---

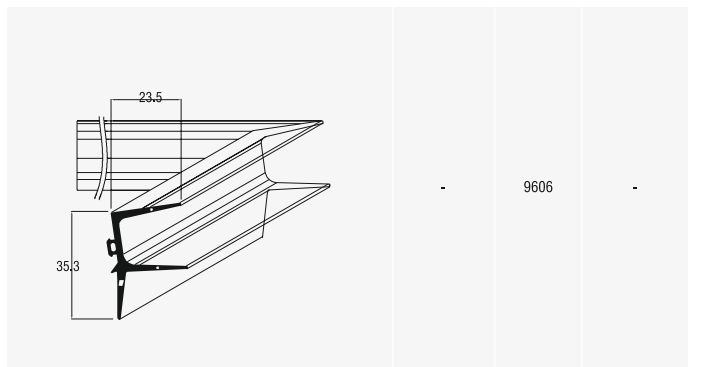































-	9606	-
---	------	---

POLYAMIDE



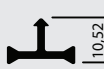

























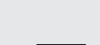





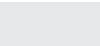





POLIAMİD ISI BARIYERLERİ
POLYAMIDE THERMAL BREAKS
Полиамидные Термоставки

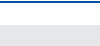

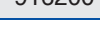













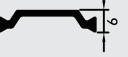



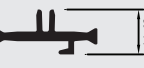

POLYAMIDE THERMAL BREAKS

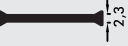
10 mm	14.8 mm	15 mm	16 mm	17.8 mm	18 mm
 911100	 911148	 911150	 911160	 911178	 911180
 913100	 913148		 913160	 915178	 913180
	 915148		 912160	 912178	 915180
12 mm					
 911120	 912148		 922160	 922178	 914180
 913120	 922148		 914160		 928180 *
14 mm					
 913140	 914148 *		 932160		
 914140	 925148 *		 924160 *		
			17 mm		
			 917601		

POLYAMIDE THERMAL BREAKS

18.6 mm	20 mm	20 mm	22 mm	24 mm	
 911186	 911200	 934200	 911220	 911240	 914240
 913186	 913200	 944200	 913220	 913240	 964240
 912186	 923200	 954200	 912220	 923240	 943240
 928186 ★	 915200	 912200 ★	 914220	 933240	 924240
	 914200	21.6 mm		 924220	 915240
	 924200	 913216	 915220 ★	 912240	 934240
	 916200			 984240 ★	 944240
	 926200			 974240 ★	 954240
				 925240	 918240
				 922240	

POLYAMIDE THERMAL BREAKS

25 mm	26 mm	26.8 mm	28 mm	30 mm
 911250	 911260	 932268	 913280	 921300
	 913260	 922268	 915280	 913300
	 914260	 912268	 916280	 915300
	 912260	27 mm	 911280	 911300
	 918260	 913270	 928280 ★	 914300
	 924260	 914270	 918280 ★	

EPDM Rubber

EPDM Rubber

EPDM Rubber

EPDM Rubber

EPDM Rubber

EPDM Rubber

EPDM Rubber

EPDM Rubber

EPDM Rubber

EPDM Rubber

EPDM Rubber

EPDM Rubber

EPDM Rubber

EPDM Rubber

EPDM Rubber

EPDM Rubber

EPDM Rubber

EPDM Rubber

EPDM Rubber

EPDM Rubber

EPDM Rubber

EPDM Rubber

EPDM Rubber

EPDM Rubber

EPDM Rubber

EPDM Rubber

EPDM Rubber

EPDM Rubber

EPDM Rubber

EPDM Rubber

www.nabat.com.tr

EPDM Rubber

EPDM Rubber

EPDM Rubber

EPDM Rubber

EPDM Rubber

EPDM Rubber

EPDM Rubber

EPDM Rubber

EPDM Rubber

EPDM Rubber

EPDM Rubber

EPDM Rubber

EPDM Rubber

EPDM Rubber

EPDM Rubber

EPDM Rubber

EPDM Rubber

EPDM Rubber

EPDM Rubber

EPDM Rubber

EPDM Rubber

EPDM Rubber

EPDM Rubber

EPDM Rubber

EPDM Rubber

EPDM Rubber

EPDM Rubber

EPDM Rubber

EPDM Rubber

EPDM Rubber

CONTACT US

📍 Beşevler Mah. Güneş Cad.
Bağcı Sok. 3B Bursa / TURKEY

☎ +90 224 452 77 84

☎ +90 224 452 77 85

📍 Talatpaşa Mah. Pazaryolu Cd.
Sedai Plaza No: 2 K:7 D:67
Esenyurt - İstanbul / TURKEY

☎ +90 212 699 84 67

📍 Factory
Yenice Organize Sanayi (Yenice OSB)
Yeniceköy Mah. 619. Sk. No:14
İnegöl - Bursa / TURKEY

☎ +90 224 452 77 84

☎ +90 224 452 77 85

✉ nabat@nabat.com.tr

🌐 www.nabat.com.tr

